

# PELLET CONTROL

Operating instruction





## CONTENTS

<b>Pellet control (External control unit)</b> .....	4
1. Content of boxes .....	4
2. Pellet control operating panel.....	4
3. Assembly of the pellet control.....	5
3.1. General information.....	5
3.2. Wall mounting, cable routing.....	5
3.3. Cable specification .....	5
4. Operation of the pellet control .....	7
5. Pellet control functions .....	7
5.1. Room set temperature.....	7
5.2. Heating times .....	8
5.3. Room set temperature, weekly heating schedule.....	9
5.4. Main menu - operating modes.....	15
5.5. Turning the stove off .....	18
- Switching over from manual operation (ON) .....	18
- Switching over from automatic operation (TM) .....	19
Heating time controlled automatic stop .....	19
Manual automatic stop.....	19
- Switching to standby using "operation mode" (SB).....	20
 <b>Menu navigation for programming the pellet control</b>	
(from stove control program version V 1.22A) .....	21

Subject to technical and visual changes; setting and printing errors excepted.

## Pellet control (external control unit)

The pellet control unit controls the basic functions of the pellet stove and permits the desired room temperature to be programmed for heating and cooling operation and control of frost protection operation. A large graphics screen displays the operational and programming functions.

### 1. Content of boxes

The boxes containing the following items:

- Pellet control with graphic screen in a plastic housing with 4-pin plug.
- Operating and assembly instructions
- 4-pin plug for connection to the main board

### 2. Pellet control operating panel

Your pellet control has a graphic screen and five input keys:

All stove settings and functions can be controlled by this unit.

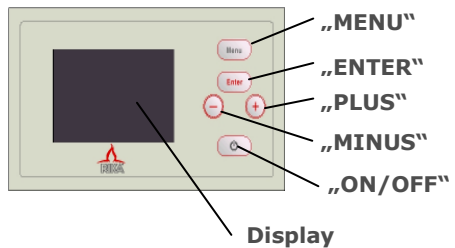

*Pellet control; push button layout*

**DISPLAY FIELD:** Display of operating mode in illuminated text.

**MENU:** Navigation within menus and to lower level menus.

**ENTER:** Navigation within the main menus and confirmation of user inputs.

**MINUS/PLUS:** Increase or reduce user values.

**ON/OFF:** Switching on or off of device.

Provides a graphical display of the menu control of program levels, see page 21.

### 3. Assembly of the pellet control

#### 3.1. General information

Danger! Remove the power plug of the stove from the wall socket before working on the device.

When assembling do not allow objects (screws, etc) to fall into the firebox or hopper - they could block the auger and damage the stove.

Before carrying out work on the stove, the stove must be switched off and cooled.

**CAUTION:** The pellet control must only be installed by authorized service technician!

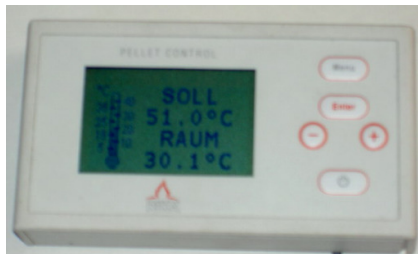

*Pellet control symbols*

#### 3.2. Wall mounting, cable routing

Remove the front of the housing by pressing sideways on the rear section. To route the cables upwards break off the press-out points provided on the housing. To route the cables downwards use the opening in the housing rear panel. Then mount the housing on the wall using the rear panel.

#### 3.3. Cable specification

To connect the operating unit you will require a commercially available 4-pin sheave cable. The cable enables all data exchange between the main board and the pellet control and the electrical supply.

We recommend that a cable length of 30 ft is not exceeded and a cable cross-section of 0,5 to 0,75 mm<sup>2</sup> is used.

In accordance with the operating instructions of your stove, remove the right-hand rear side panel or the rear panel.

After routing the cable, guide the cable through the plastic grommet (figure 1). Push it through the bracket and connect to connector 3 (figure 2).

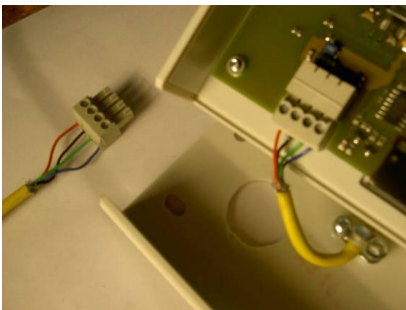

*Fig. 1: Routing of cable through, rear panel*



*Fig. 2: Plug position on the main board*

Connect the control cable in the correct wire sequence to the 4-pin plug supplied (as shown in figure 4). Plug the plug into the socket of the pellet control. Now snap the front section of the pellet control into the rear housing panel.



*Fig. 3: Multiple pin strip cable of the pellet control*

## 4. Operation of the pellet control

Once installation is complete you can reconnect your device to the mains. When using the pellet control, the internal control unit = user board does not display any information. The pre-stored data of the internal control unit is automatically accessed by the pellet control.

## 5. Pellet control functions

The pellet control takes care of the following basic functions of your pellet stove:

- Manual operation
- Automatic operation
- Standby mode

In addition the following comfort functions are provided:

- Room set temperature instead of heat output modulation
- Reduced temperature outside pre-set heating periods
- Frost protection mode<sup>1</sup>

The user can choose a set temperature of ON (AUTOM. TEMP ON) and OFF (AUTOM. TEMP OFF). This permits a energy savings function that maintains the system at a lower set temperature outside the heating periods. The set temperature for OFF works only in automatic operation. An frost protection temperature can also be entered. If the room temperature falls below this value the frost protection mode is activated and the system is regulated to "set temperature, anti-freezing operation". The frost protection mode is only active if (AUTOM.TEMP OFF) is set to OFF. Otherwise outside the heating periods the stove is regulated to the set temperature (reduced temperature).

### 5.1. Room set temperature

The room set temperature can be programmed to the following values (tab. 1):

---

<sup>1</sup> from stove control program version V 1.22A (see operating instruction of the pellet stove)

Room temp. ON	0-220 °F	Display of the desired temperature for state ON
Room temp. OFF	OFF, 0-220 °F	OFF indicates that the stove is turned off. Otherwise controls regulate to maintain programmed temperature
Frost protection Min. temp.	0-220 °F	Frost protection will be activated, if stove is turned off in OFF and if room temperature fell below frost protection min. temp.
Frost protection Max. temp.	0-220 °F	Target temperature, which the stove operation maintains when frost protection is active.

*Tab.: 1: Value range for room set temperature*

## 5.2. Heating times

For each day of the week two heating times can be set. These are defined in each case by a switching on and switching off point ("from" "to" corresponds to "ON", "OFF"). In contrast to the internal operation unit the setting is in minutes.

Monday	ON 1	hh:mm	Start time for heating periode 1
	OFF1	hh:mm	End time for heating periode 1
	ON 2	hh:mm	Start time for heating periode 2
	OFF2	hh:mm	End time for heating periode 2
Tuesday	ON 1	hh:mm	...
	OFF1	hh:mm	
	ON 2	hh:mm	
	OFF2	hh:mm	
...	...	...	...
Sunday	ON 1	hh:mm	...
	OFF1	hh:mm	
	ON 2	hh:mm	
	OFF2	hh:mm	

*Tab.: 2: Day, hour format*

Example value for hh:mm: 12 hrs : 45 min



### 5.3. Room set temperature, weekly heating schedule

When you first plug-in your stove to the power outlet (with the pellet control installed), the following information appears on the pellet control display:



This symbol indicates that the control is in the standby position and is ready for operation.

Now program the control for your individual requirements as follows:

Two heating periods can be programmed for each day of the week. No heating periods are programmed by the factory (all times are set to 00:00).

Press "MENU" on the pellet control and the following appears on the graphic display:

1 234567

ON 1 00:00  
OFF1 00:00  
ON 2 00:00  
OFF2 00:00

„1“ (inverted) stands for Monday.

„00:00“ indicates in each case hours (0 to 23) : minutes (0 to 59)

„ON 1“ indicates the start of the first heating period

„OFF1“ indicates the end of the first heating period

„ON 2“ indicates the start of the second heating period

„OFF2“ indicates the end of the second heating period

Press „ENTER“ and the display appears:

1 234567

ON 1 00:00  
OFF1 00:00  
ON 2 00:00  
OFF2 00:00

The hour for ON 1 is inverted and can be changed in steps of one hour as desired by pressing "+" and "-". The required setting is confirmed and saved with "ENTER". The display shows:

1 234567

ON 1 06:00  
OFF1 00:00  
ON 2 00:00  
OFF2 00:00

The minute for ON 1 is inverted and can be changed in steps of one minute as desired by pressing "+" and "-". The required setting is confirmed and saved with "ENTER". The display shows:

1 234567

ON 1 06:15  
OFF1 00:00  
ON 2 00:00  
OFF2 00:00

The hour for OFF 1 is inverted and can be changed in steps of one hour as desired by pressing "+" and "-". The required setting is confirmed and saved with "ENTER". The display shows:

1 234567

ON 1 06:15  
OFF1 09:00  
ON 2 00:00  
OFF2 00:00

The minute for OFF 1 is inverted and can be changed in steps of one minute as desired by pressing "+" and "-". The required setting is confirmed and saved with "ENTER". The display shows:

1 234567

ON 1 06:15  
OFF1 09:20  
ON 2 00:00  
OFF2 00:00

The hour for ON 2 is inverted and can be changed in steps of one hour as desired by pressing "+" and "-". The required setting is confirmed and saved with "ENTER". The display shows:

1 234567

ON 1 06:15  
OFF1 09:20  
ON 2 16:00  
OFF2 00:00

The minute for ON 2 is inverted and can be changed in steps of one minute as desired by pressing "+" and "-". The required setting is confirmed and saved with "ENTER". The display shows:

1 234567

ON 1 06:15  
OFF1 09:20  
ON 2 16:05  
OFF2 00:00

The hour for OFF 2 is inverted and can be changed in steps of one hour as desired by pressing "+" and "-". The required setting is confirmed and saved with "ENTER". The display shows:

1 234567

ON 1 06:15  
OFF1 09:20  
ON 2 16:05  
OFF2 20:00

The minute for OFF 2 is inverted and can be changed in steps of one minute as desired by pressing "+" and "-". The required setting is confirmed and saved with "ENTER". The display shows:

1 234567

ON 1 06:15  
OFF1 09:20  
ON 2 16:05  
OFF2 20:50

The heating periods for Monday are now programmed as required. Monday is terminated using "MENU" and the display shows:

1 2 3 4 5 6 7

ON 1 00:00  
OFF1 00:00  
ON 2 00:00  
OFF2 00:00

„2“ (inverted) stands for Tuesday.

Press „ENTER“ and the display appears:

1 2 3 4 5 6 7

ON 1 00:00  
OFF1 00:00  
ON 2 00:00  
OFF2 00:00

The display shows the hour (inverted) for the first heating time on Tuesday.

Now enter all the other heating time settings for Tuesday and for the remaining days of the week (Wednesday "3", Thursday "4", Friday "5", Saturday "6", Sunday "7") as described above.

Press "ENTER" to quit the OFF2 value for Sunday (7) and select "MENU", the following then appears on the display:

AUTOM  
TEMP

ON 71 °F  
OFF OFF

"AUTOM TEMP" is the field for room set temperature in the heating periods.

"ON" for room set temperature during the programmed heating periods (ON1 to OFF1 and ON 2 to OFF 2).

"OFF" room set temperature (room temperature energy savings) between the programmed heating periods. (OFF1 to ON2 and OFF2 to ON1). In this time period the value 'OFF' switches the stove off and activates anti-freezing operation.

AUTOM  
TEMP

ON 62 °F  
OFF OFF

The room temperature set value for ON is displayed inverted and can be changed in steps of 1 °F by using the "+" and "-" keys. The new value is confirmed using "ENTER" and the following display appears:

AUTOM  
TEMP

ON 71 °F  
OFF OFF

The room temperature set value for OFF is displayed inverted and can be changed in steps of 1 °F by using the "+" and "-" keys.

For a room set temperature of OFF the device is switched OFF and the frost protection mode is activated.

The required setting is confirmed and saved with "ENTER". The display shows:

CLEAN  
MODE

060 MIN

"CLEAN" indicates the cleaning function. The number shows the length of the cleaning interval in minutes (e.g. see Window 60 minutes).

You can set the required cleaning interval in 5 minute steps using "+" and "-" (the cleaning interval can be extended to a maximum of 300 minutes, however, we recommend maintaining a 60-minutes cleaning cycle).

The value is confirmed by pressing "ENTER" and the display shows:



MINIM. TEMP.

40 °F

The symbol stands for ant-freezing operation.

"MINIM TEMP" is the parameter for minimum room set temperature at which anti-freezing operation switches on.

By pressing "+" and "-" the minimum room set temperature for the anti-freezing operation can be set and confirmed with "ENTER". The display then shows:



MAX. TEMP.

50 °F

The symbol stands for ant-freezing operation.

"MAX TEMP" is the parameter for maximum room set temperature which the frost protection operation regulates to.

By pressing "+" and "-" the maximum room set temperature for the anti-freezing operation can be set and confirmed with "ENTER". Then press the "MENU" key and the display shows:

TIME

13:48 - 2

VERS: 1.22A

"TIME" is the parameter for the system clock.

"13:48 - 2" indicates the time (hours:minutes) and the second day (=Tuesday) of the week.

“VERS” stands for the actual stove control program version (indication only)

With the “+” and “-“ keys the current time (highlighted) is set and quit using “ENTER” and the display shows:

TIME  
13:48 - 2  
VERS:1.22A

Set the current minute (highlighted) using “+” and “-“ and quit with “ENTER” and on the display appears:

TIME  
13:48 - 2  
VERS:1.22A

Select the current day of the week (highlighted) (1=Monday, 2=Tuesday) using “+” and “-“ and accept with “ENTER” and the display shows:



STANDBY

This symbol indicates that the control is in standby mode.

#### NOTE:

**When the stove is in ON mode heating operation starts after about 10 seconds. In the automatic mode the start-up of the heating process is dependent on the programmed heating times.**

Now your stove is programmed according to your individual requirements and can be set to the manual mode (ON mode) by **pressing** the “ENTER” key **once**, the display then shows:

°C  
35  
30  
25  
15  
5  
72°F  
TEMP.  
72°F

“72°F” is an example of the room set temperature.

“72°F” is the current room temperature.

The room set temperature can be changed from 0 to 220 °F using “+” and “-“. The new value is used immediately for control. If the room temperature reaches the room set temperature, the indicator for the current room temperature extinguishes.

Upon reaching the room temperature, the stove is switched off. If the room temperature falls below the room set temperature by 4 °F, the stove is re-started and remains in operation until the room set temperature is reached again.

**Press “ENTER” twice** to set the pellet stove to the automatic mode (TM mode) and the display shows:

**IMPORTANT:**

The clock symbol (colored red) indicates automatic mode.

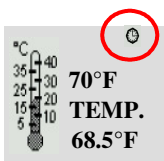

“70 °F” indicates an example room set temperature.

“68,5 °F” is the current room set temperature.

The room temperature set value is determined by the programmed value “AUTOM TEMP ON” and in cooling operation by “AUTOM” TEMP OFF”. This value can also be changed temporarily using “+” and “-“ and will be maintained until the end of the current heating interval.

If the “AUTOM” TEMP OFF” value is programmed to OFF the following indications appear outside of the programmed heating times:



The clock symbol (coloured red) indicates the automatic mode.

The symbol indicates that the control is at standby.

“OFF” indicates that the pellet stove is switched off and is waiting for anti-freezing operation or for the next programmed heating interval.

## 5.4. Main menu – operating modes

According to your requirements you can choose between the following three operating types described below.

- **Standby-mode:**



This symbol indicates that the control is in standby mode.

- **Manual control (room temperature controlled):**

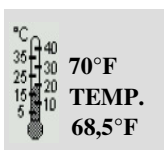

“70 °F” indicates an example room set temperature.

“68.5 °F” is the actual room temperature.

- **Automatic operation (heating times, room temperature controlled):**

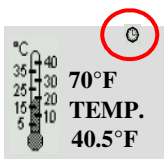

The clock symbol (colored red) indicates the automatic mode.

“70 °F” indicates an example room set temperature.

“68.5 °F” is the current room temperature.

- **Automatic operation (frost protection mode)**

If the “AUTOM TEMP OFF” value is programmed to OFF, the following indication appears outside the programmed heating periods:



The clock symbol (colored red) indicates the automatic mode.

The symbol indicates that the clock is in standby.

“OFF” indicates that the pellet stove is switched off and standing by for frost protection operation or the next programmed heating period.

The individual operating modes can be changed by selecting “ENTER”.

### Start manual operation (ON-mode)

The following indications appear alternatively on the display:

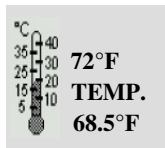
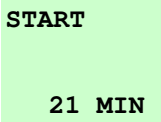

„START“ indicates start:

The number below indicates the remaining minutes (here 21) of the start-up cycle.

From the end of the start phase until reaching the room set temperature the display shows:



If you wish to change the current room set temperature you can adjust it in steps of 1 °F (from 0 °F to 220 °F) by pressing “+” and “-”.



## Start automatic operation (TM mode)

If automatic operation is selected on the display and the programmed heating time begins, the control starts the heating operation.

The following alternating indication appears on the display:

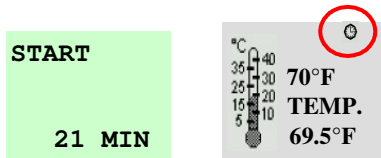

„START“ indicates start.

The number below indicates the remaining time for the start procedure in minutes (here 21).

On completion of the start-up cycle the following appears on the display until the room set temperature is reached:

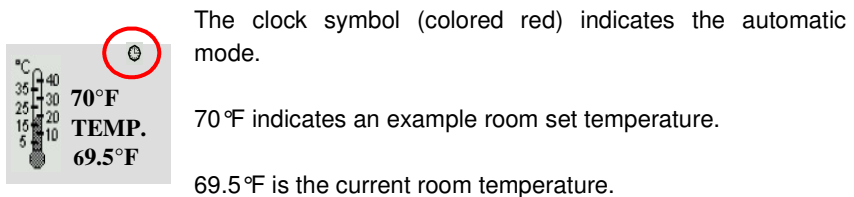

### Note:

The heating program runs through automatically and can be interrupted by the user by changing (ENTER key) the operating mode to “SB” (standby). In this case the shut down (see “EXIT”, below) is run **completely**.

If during the start phase the device is disconnected from the outlet (e.g. power outage) and then re-connected to the mains, the start-up cycle is initiated from the beginning again.

## 5.5. Turning the stove off

- **Switching over from manual operation (ON)**

If the “ON/OFF” switch is pushed during operation or the room set temperature reached, then the shut-down program is activated. The display shows the following alternating indications:

**EXIT 1**

**60 SEC**



“EXIT 1” indicates exit first phase.

The number below shows the remaining time for the final cleaning delay in seconds (here 60).

On completion of EXIT 1 the following alternatively appears on the display:

**CLEAN**

**120 SEC**



„CLEAN“ indicates clean.

The number below shows the remaining time for final cleaning in seconds (here 120).

On completion of CLEAN the following alternatively appears on the display:

**EXIT 2**

**300 SEC**



“EXIT 2” indicates exit second phase.

The number below shows the remaining time until exit in seconds (here 300).

On completion of EXIT 2 the display goes dark. Re-start commences only if the “ON/OFF key is pressed.

**Note:**

The full shut-down process lasts for about 8 minutes and cannot be interrupted by the user. Operation of “ON/OFF” causes the shut-down to be re-initiated.

- **Switching over from automatic operation (TM)**

Heating time controlled automatic stop

If in automatic operation “AUTOM TEMP OFF” is set to “OFF”, then the stove will be shut down upon completion of the functions described above.

On completion of the shut-down phase the following appears on the display:



The clock symbol (red marking) indicates the automatic mode. The symbol indicates the standby state of the controls.

“OFF” indicates that the pellet stove is switched off and is waiting for frost protection operation or for the next programmed heating period.

The stove is re-started to operate automatically by the start of a programmed heating period or can be started any time manually by the user by switching to the ON mode (e.g. when heat is needed outside the programmed heating periods).

Manual automatic stop

If during automatic operation “ON/OFF” is pushed, the stove switches automatically to the shut-down phase. The same display appears as mentioned above.

On completion of the EXIT 2 phase the display darkens and the device can only be re-set to automatic mode by pushing the “ON/OFF” button.

- **Switching to standby using “operation mode“ (SB)**

If you press the “ENTER” key to switch out of “manual operation” or from “automatic operation” to “standby mode” a starting procedure as described above will be carried out.

On completion of the switching program the following appears on the display:



To restart operation a corresponding mode must be selected, or the device must be started using the optional Tele-Control (telephone start).

**Note that when the stove is in ON mode, heating operation starts after about 10 seconds. In automatic mode (TM) the start of the heating process is dependent on the programmed heating periods.**

## Menu flow chart for programming the pellet control (from stove control program version V 1.22A)

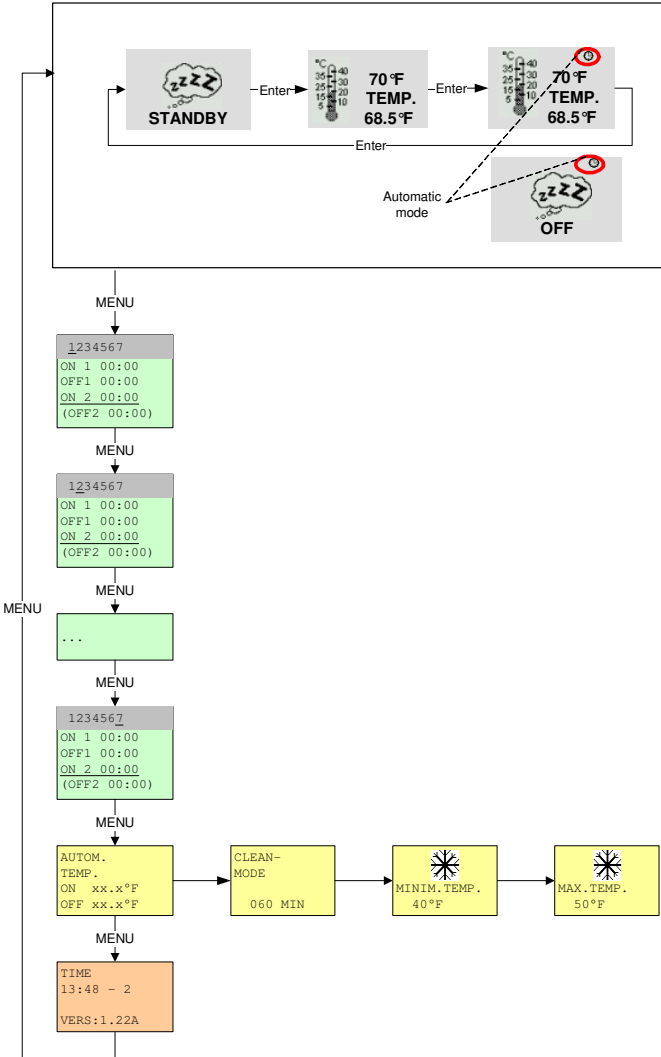

**Menu level:**  
Selection for operating mode

**Programming for heating time:**  
For each day of the week, two heating periods can be programmed. A heating period is defined by start times (ON1, ON2) and end times (OFF1, OFF2).

**Target temperature:**  
Pre-set desired temperature during heating periods (ON) and outside heating periods (OFF); Set up of cleaning interval (CLEAN-MODE); Set up of frost protection

**System time:**  
Set up of hours, minutes and weekday; 1 equals Monday; Display of software version







Administration/Sales:

RIKA Metallwarenges.m.b.H & Co KG  
Müllerviertel 20  
A-4563 Micheldorf  
Tel: 0043(0)7582/686-41  
Fax: 0043(0)7582/686-43  
Email: [verkauf@rika.at](mailto:verkauf@rika.at)  
[www.rika.at](http://www.rika.at)

Production/Goods inwards and outwards store:

A.G.Z.  
Adlwanger Gewerbe Zentrum  
Brandmühlestrasse 6  
A-4541 Adlwang